

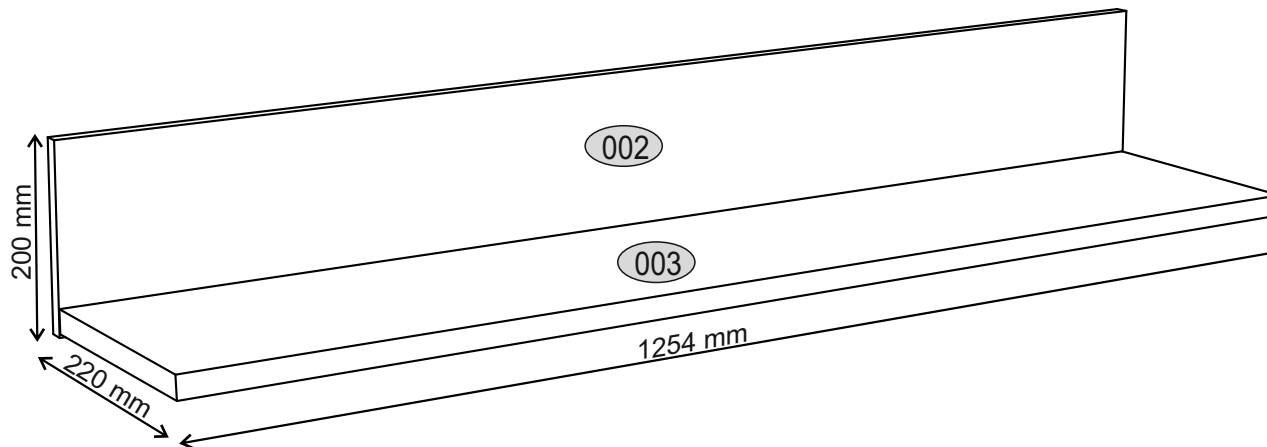

Installation manual

AYSON: półka 130

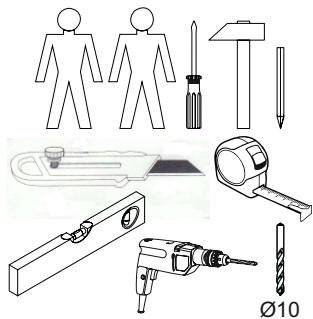
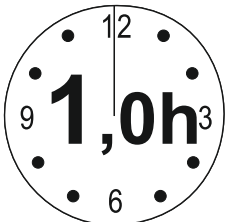

Code	Dimensions				Package
002	1254	200	16	1	1/1
003	1252	204	22	1	1/1
accessories				1	1/1

x5
e1

Ø 7x50mm



x6
f1

Ø 8x30mm



x2
g2



x2
e19

Ø6x9 mm



x2
e3

Ø6x13 mm



x1
z1



x2
f3

Ø10x50 mm



x2
p17

Ø5x60 mm

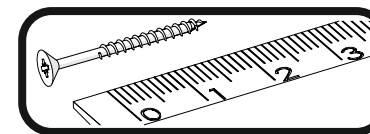
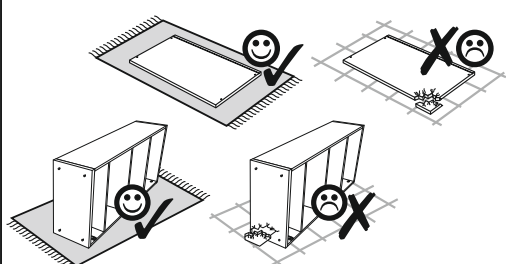
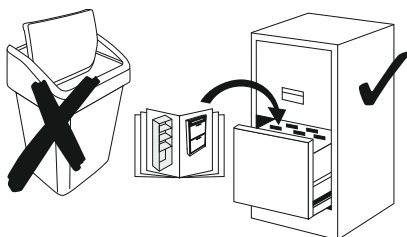

1

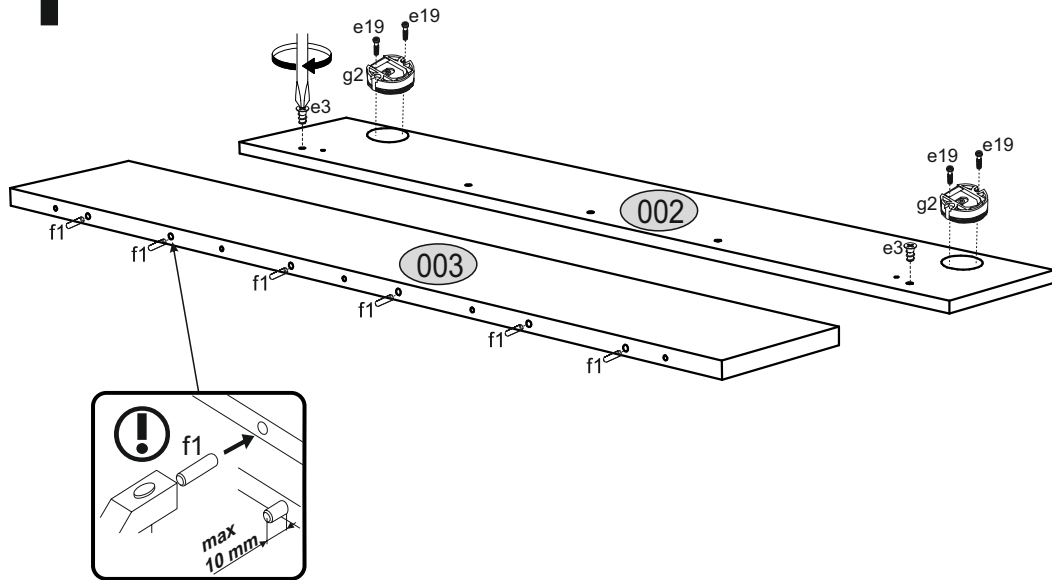

2

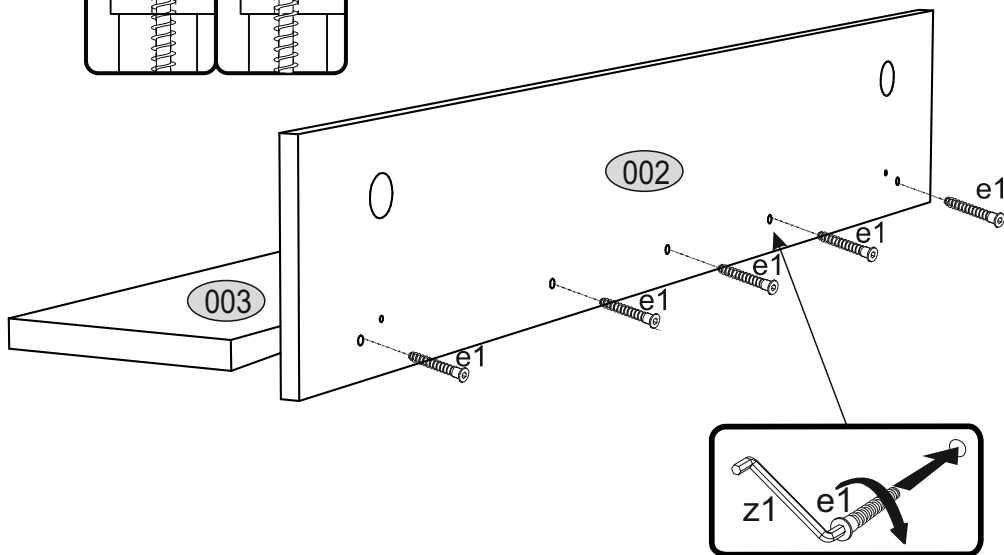
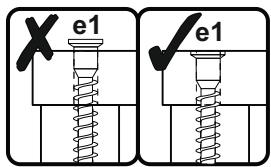

3

