

# INSTRUKCJA MONTAŻU

FITTING-UP INSTRUCTION / AUFBAUANLEITUNG

MONTÁŽNÍ NÁVOD / MONTÁŽNY NÁVOD / SZERELÉSI UTASÍTÁS

Producent:  
**Restol sp. z o.o.**  
36-055 BRATKOWICE  
www.restol.com.pl

## Thea White WHS-2

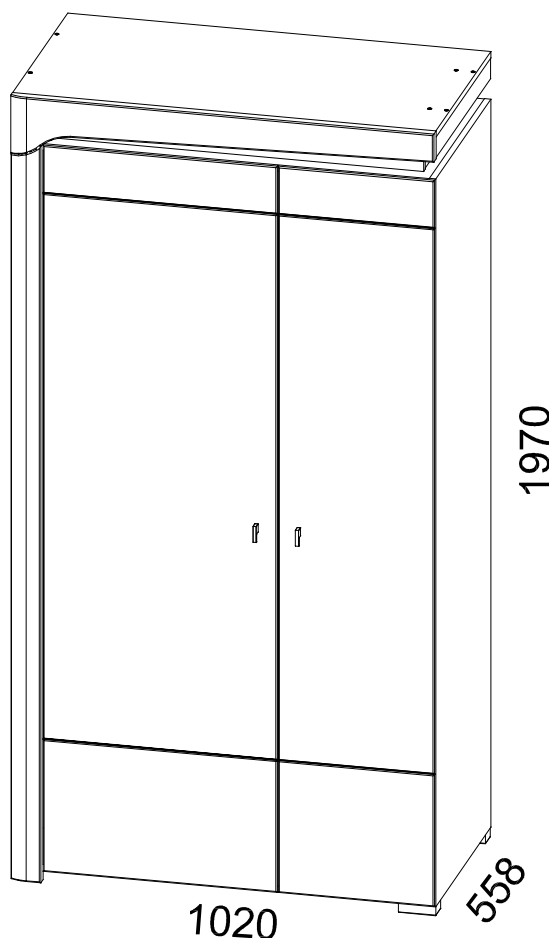
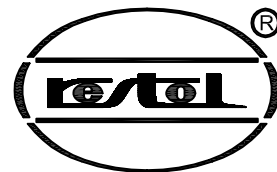

1020 x 1970 x 558 /mm/

### **WSKAZÓWKA na temat pielęgnacji mebla.**

Czyścić elementy wilgotną szmatką lub papierowym ręcznikiem.  
Nie używać chemicznych środków czyszczących.

#### **DIRECTION for the furniture cleaning.**

Clean elements with the moist wiper or soft paper towel. Do not use any detergents.

#### **Pflegehinweis.**

Nur mit feuchtem Lappen, bzw. Papiertuch Ihre Möbel reinigen.  
Keine chemischen Waschmittel einsetzen.

#### **POKYN pro ošetřování nábytku!**

Díly čistit vlhkým hadříkem nebo papírovou utěrkou.  
Nepoužívat chemické čističí prostředky.

#### **POKYNY k údržbe nábytku.**

Prvky nábytku čistit vlhkou handričkou alebo papierovou utierkou  
Nepoužívať chemické čistiace prostriedky.

#### **UTMATATÓ a bútor ápolására.**

Az elemeket nedves ronggyal vagy papírtörülközővel tisztítani.  
Vegyí tisztítószert nem használni.

Gwarancja dostępna pod linkiem:

Guarantee available at:

Die Garantie ist unter dem Link:

Záruka je k dispozíci na

následujícím odkazu:

Záruka k dispozícii pod odkazom:

Link a jótálláshoz :

[www.restol.com.pl/gwarancja.pdf](http://www.restol.com.pl/gwarancja.pdf)

**INSTRUKCJA MONTAŻU**  
 FITTING-UP INSTRUCTION / AUFBAUANLEITUNG  
 MONTÁŽNÍ NÁVOD / MONTÁŽNY NÁVOD / SZERELÉSI UTASÍTÁS

# Thea White WHS-2



Do montażu potrzebne są:  
 You need for fitting-up:  
 Zur Montage werden Sie brauchen:  
 K montáži jsou potřebné:  
 Na montáž potrebujete:  
 A szereléshez szükséges:

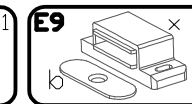
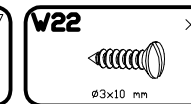
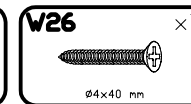
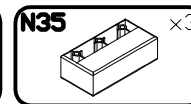
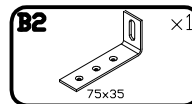
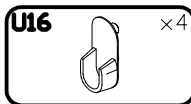
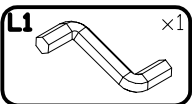
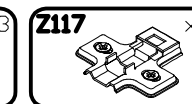
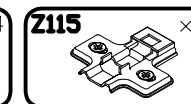
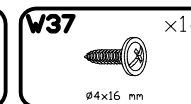
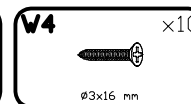
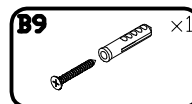
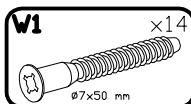
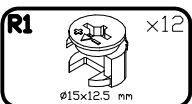
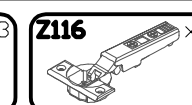
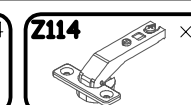
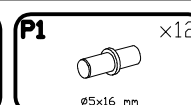
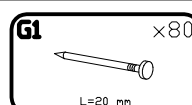
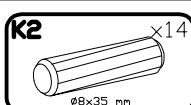
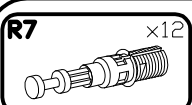
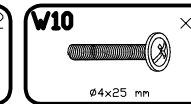
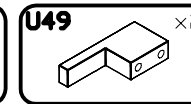
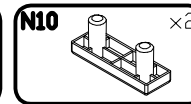
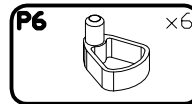
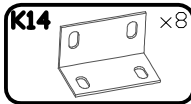
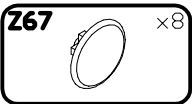
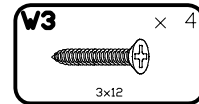
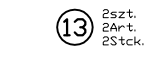
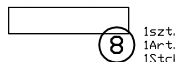
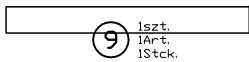
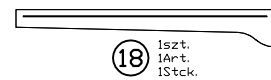
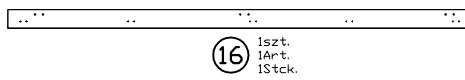
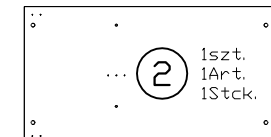
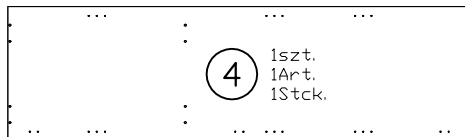
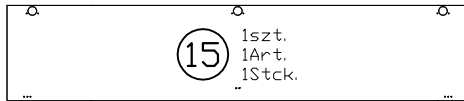
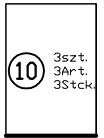
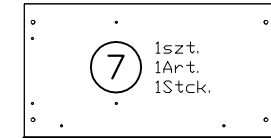
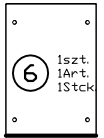
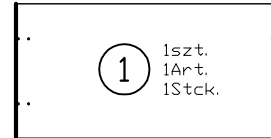
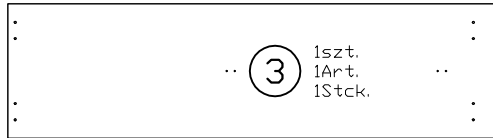
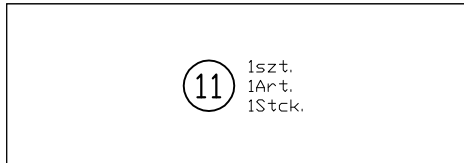
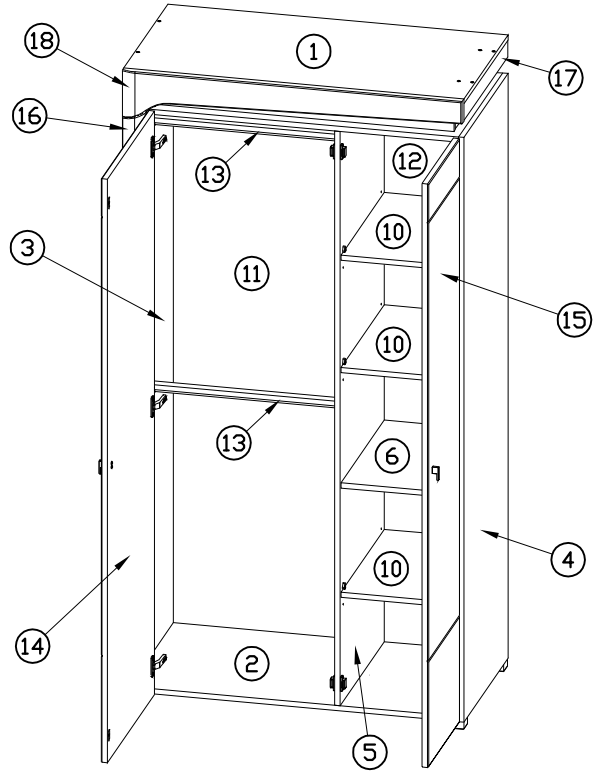
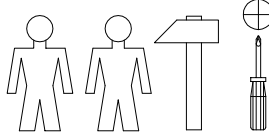

**PODCZAS MONTAŻU POSTĘPOWAĆ ZGODNIE Z INSTRUKCJĄ**

WHILE ASSEMBLING FOLLOW THE INSTRUCTION / MONTAGE LAUT DER AUFBAUANLEITUNG DURCHFÜHREN

PŘI MONTÁŽI POSTUPOVAT PODLE NÁVODU / PRI MONTÁŽI POSTUPOJTE PODĽA NÁVODU / SZERELÉSKOR UTASÍTÁS SZERINT ELJÁRNI

**1** Then White **WHS-2**

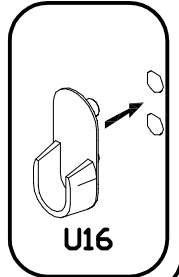
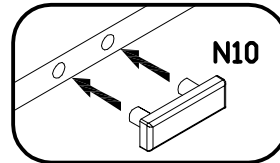
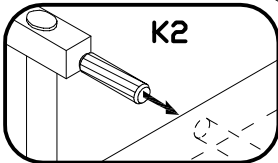
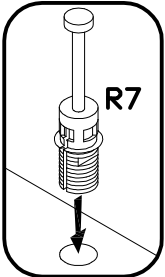
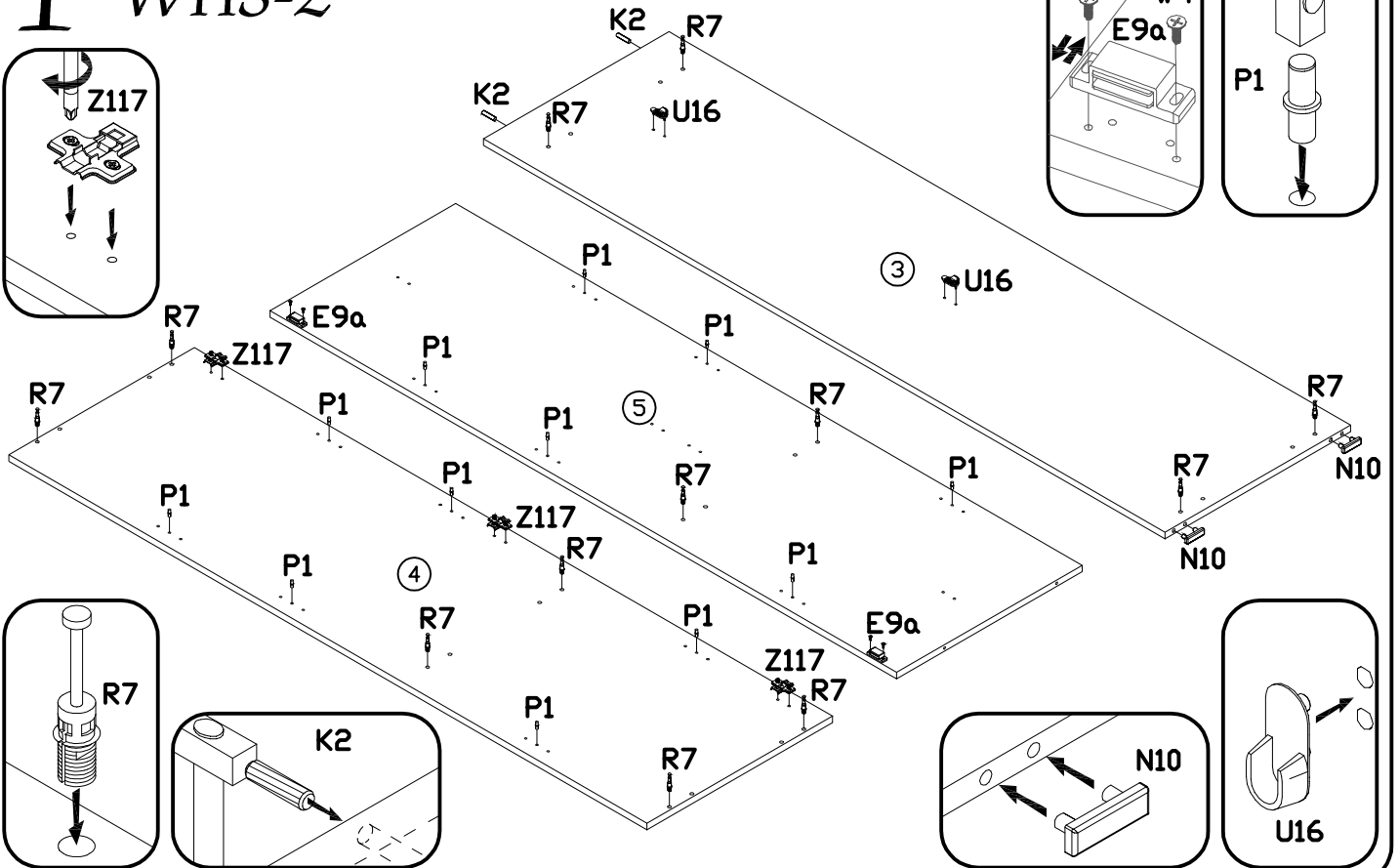
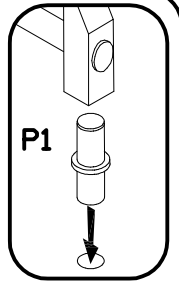
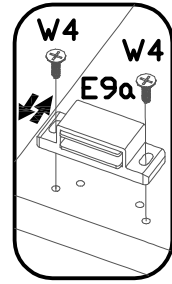
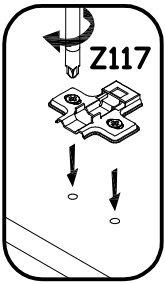

**2** Then White **WHS-2**

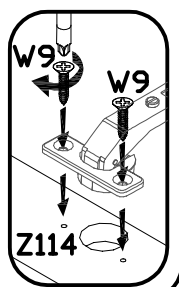
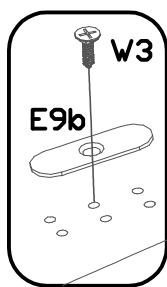
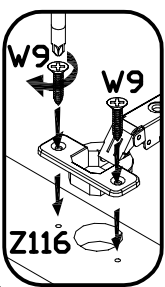
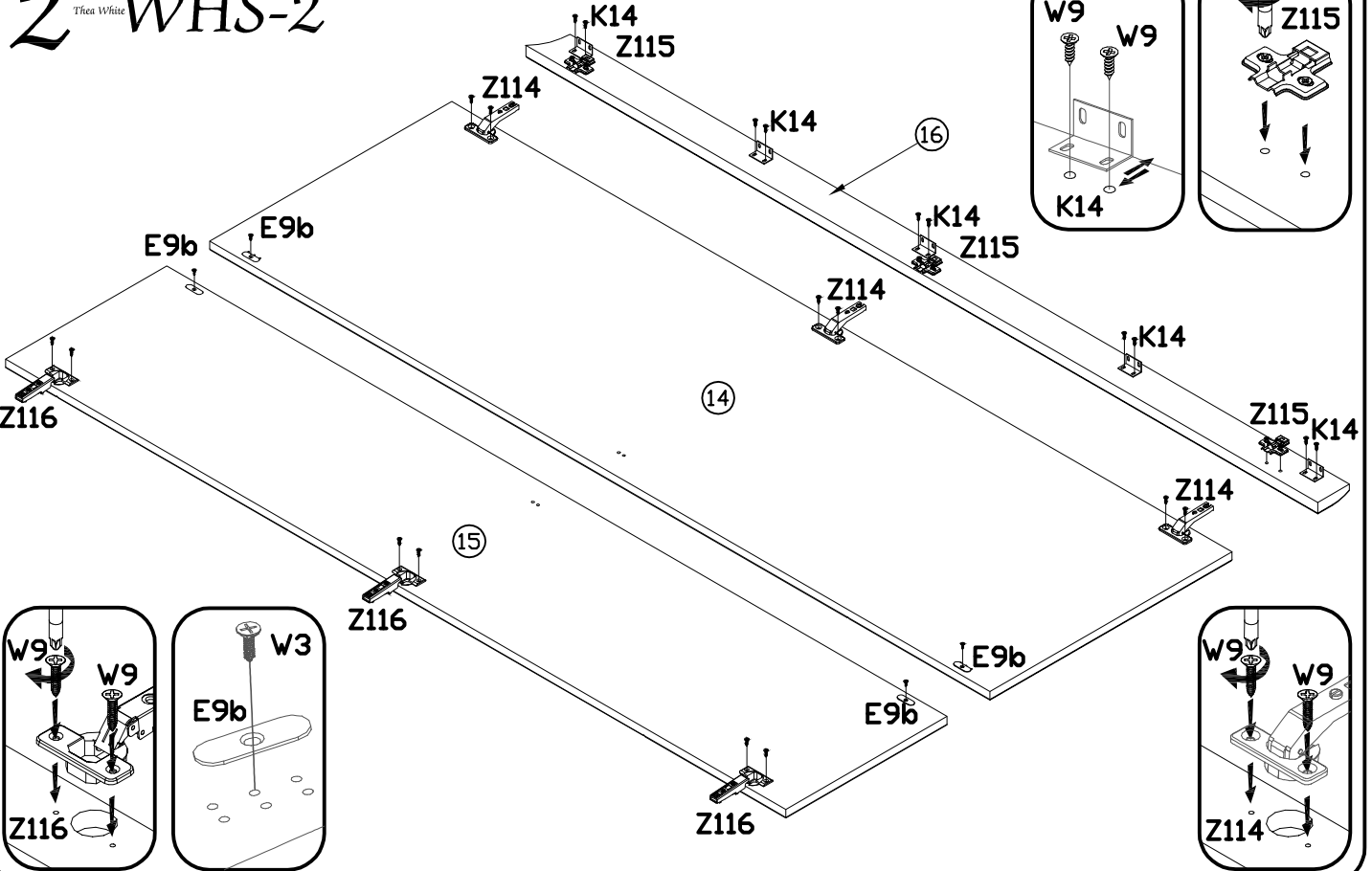
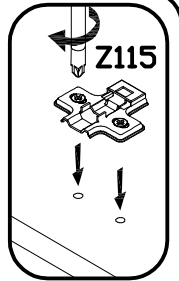
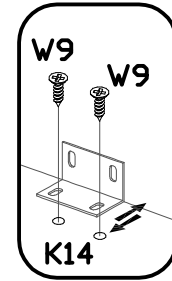

**PODCZAS MONTAŻU POSTĘPOWAĆ ZGODNIE Z INSTRUKCJĄ**

WHILE ASSEMBLING FOLLOW THE INSTRUCTION / MONTAGE LAUT DER AUFBAUANLEITUNG DURCHFÜHREN

PŘI MONTÁŽI POSTUPOVAT PODLE NÁVODU / PRI MONTÁŽI POSTUPOJTE PODĽA NÁVODU / SZERELÉSKOR UTASÍTÁS SZERINT ELJÁRNI

**3** Then White **WHS-2**

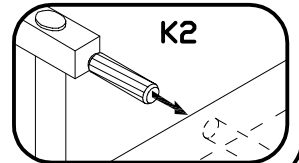
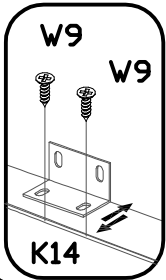
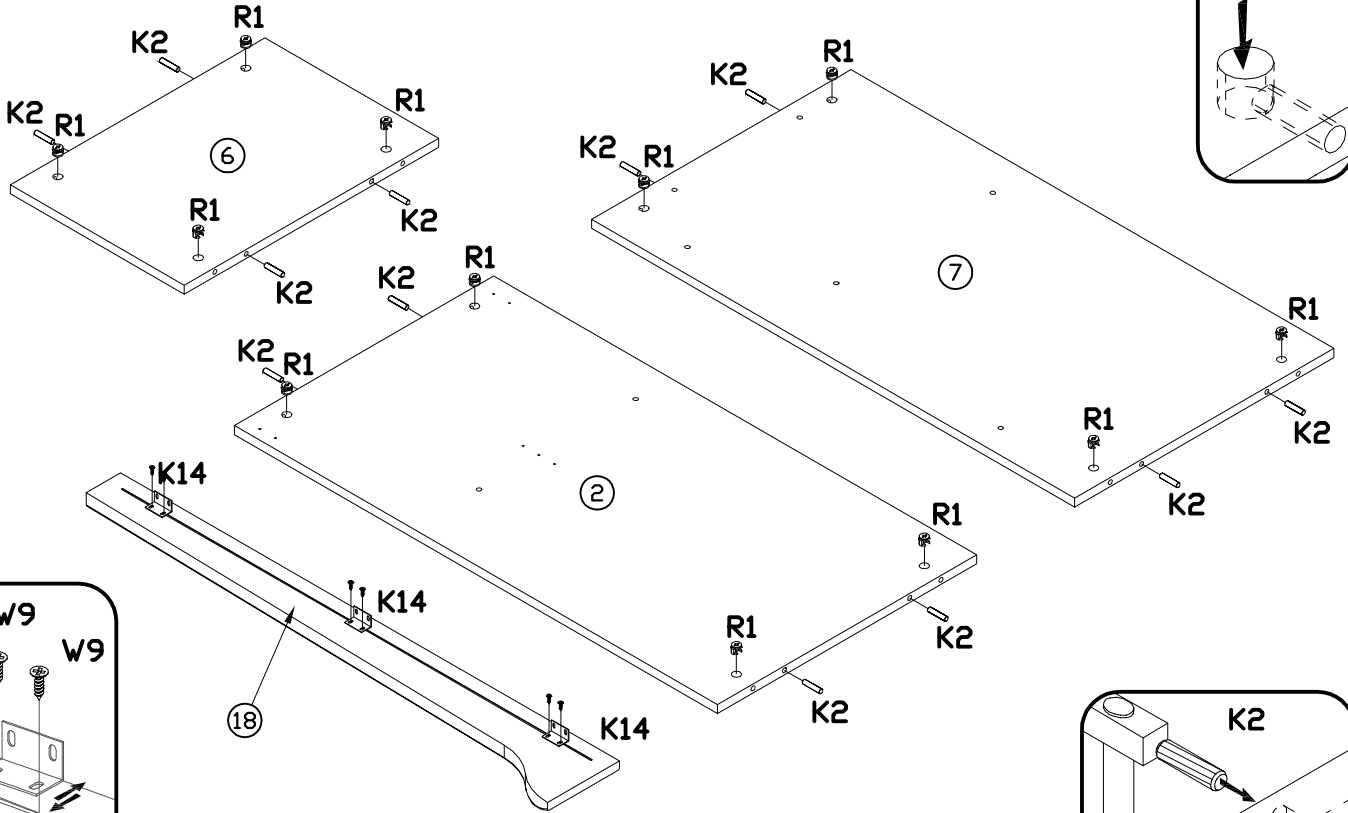
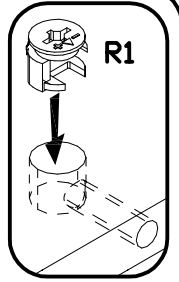

**4** Then White **WHS-2**

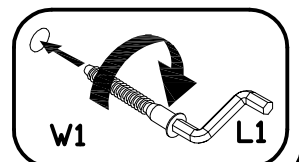
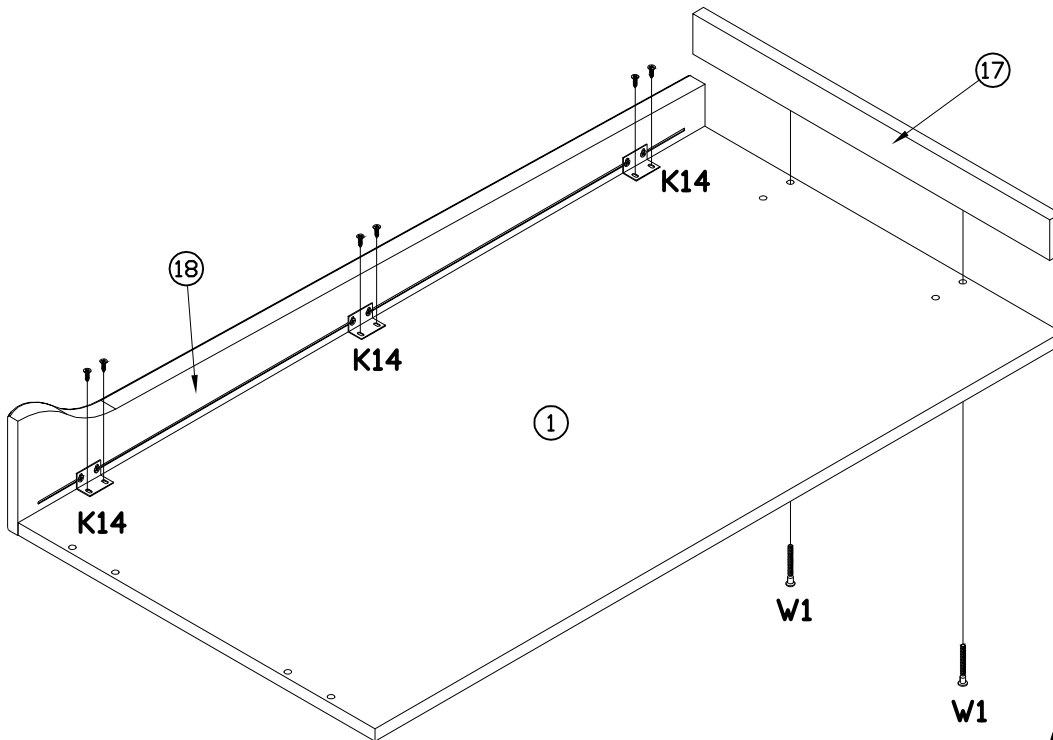
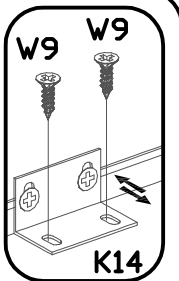

**PODCZAS MONTAŻU POSTĘPOWAĆ ZGODNIE Z INSTRUKCJĄ**

WHILE ASSEMBLING FOLLOW THE INSTRUCTION / MONTAGE LAUT DER AUFBAUANLEITUNG DURCHFÜHREN

PŘI MONTÁŽI POSTUPOVAT PODLE NÁVODU / PRI MONTÁŽI POSTUPOJTE PODĽA NÁVODU / SZERELÉSKOR UTASÍTÁS SZERINT ELJÁRNI

# 5 Free White WHS-2 - Opcja NEO-8

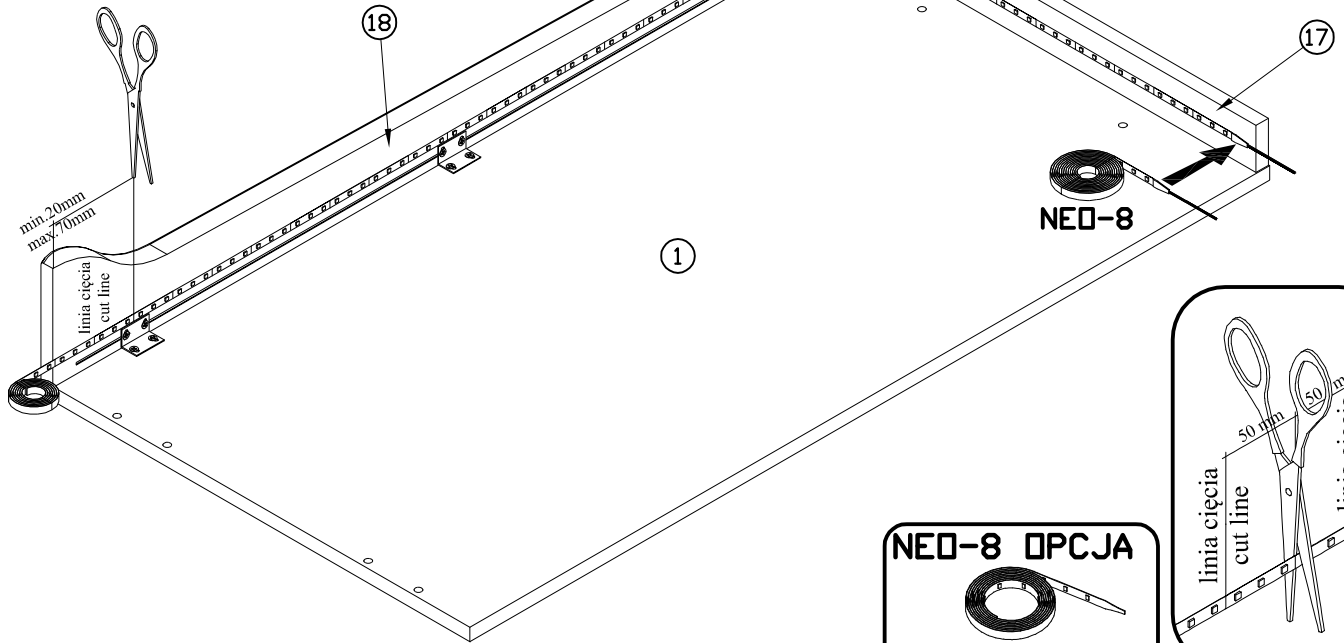
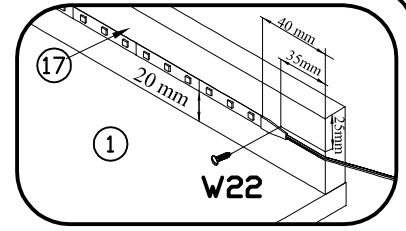

# 6 Free White WHS-2

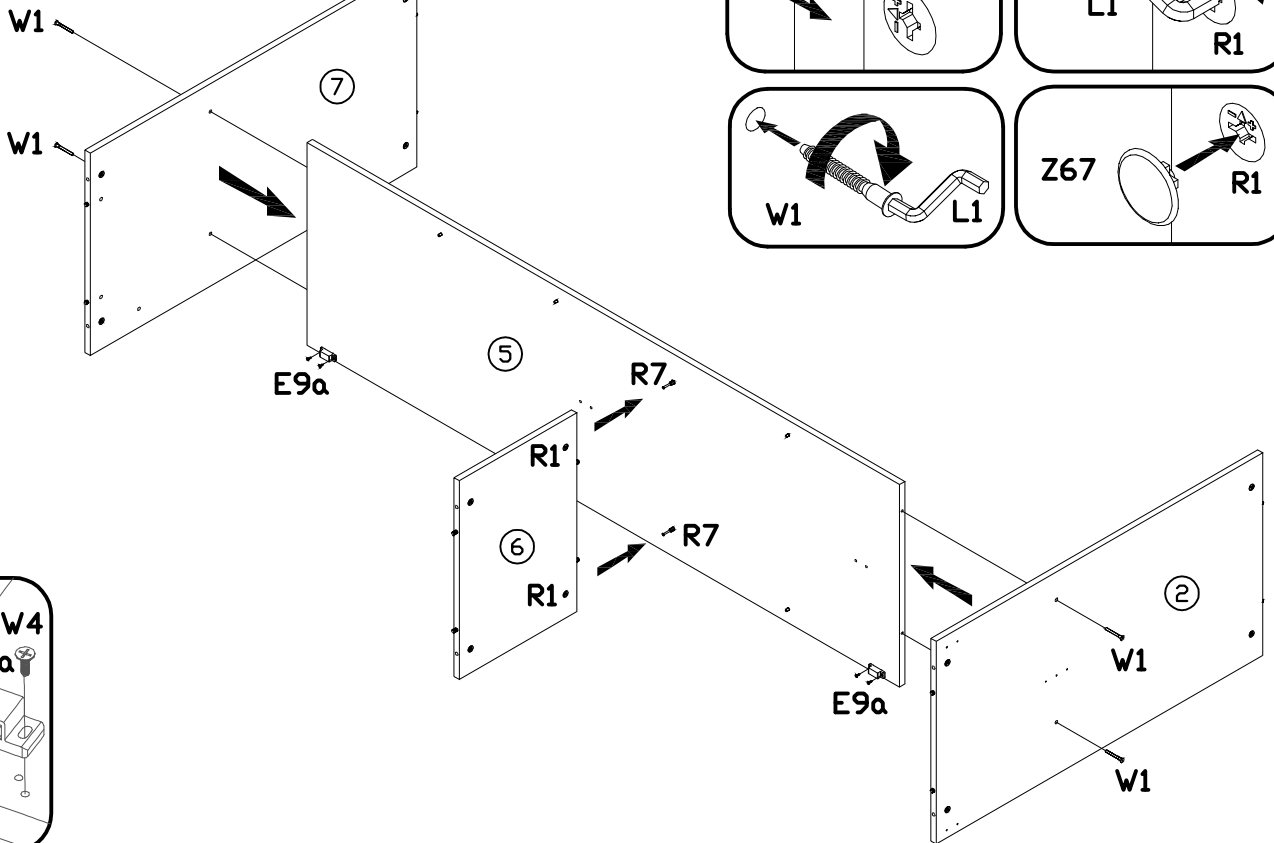

**PODCZAS MONTAŻU POSTĘPOWAĆ ZGODNIE Z INSTRUKCJĄ**

WHILE ASSEMBLING FOLLOW THE INSTRUCTION / MONTAGE LAUT DER AUFBAUANLEITUNG DURCHFÜHREN

PŘI MONTÁŽI POSTUPOVAT PODLE NÁVODU / PRI MONTÁŽI POSTUPOJTE PODĽA NÁVODU / SZERELÉSKOR UTASÍTÁS SZERINT ELJÁRNI

**7** Then White **WHS-2**

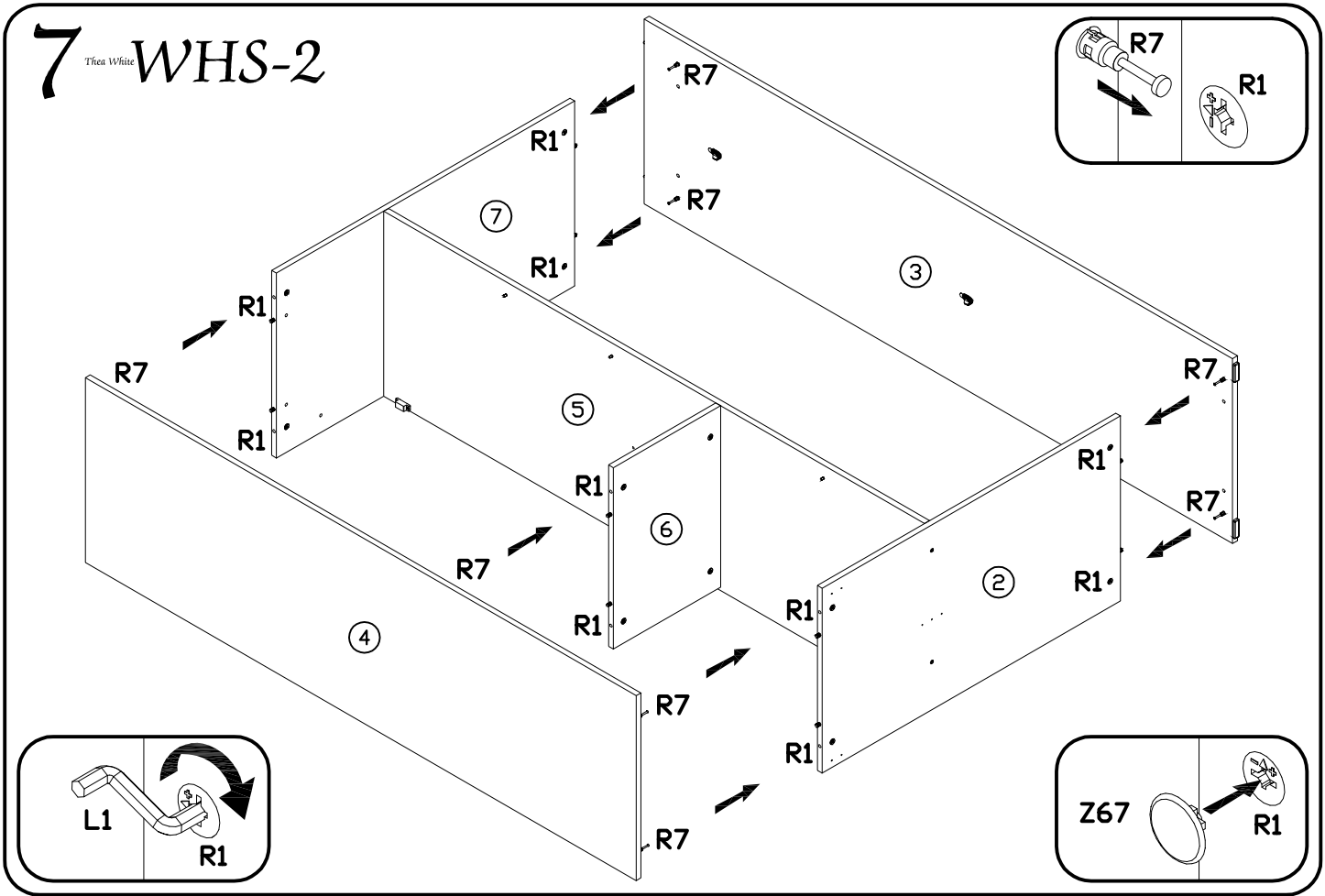

**8** Then White **WHS-2**

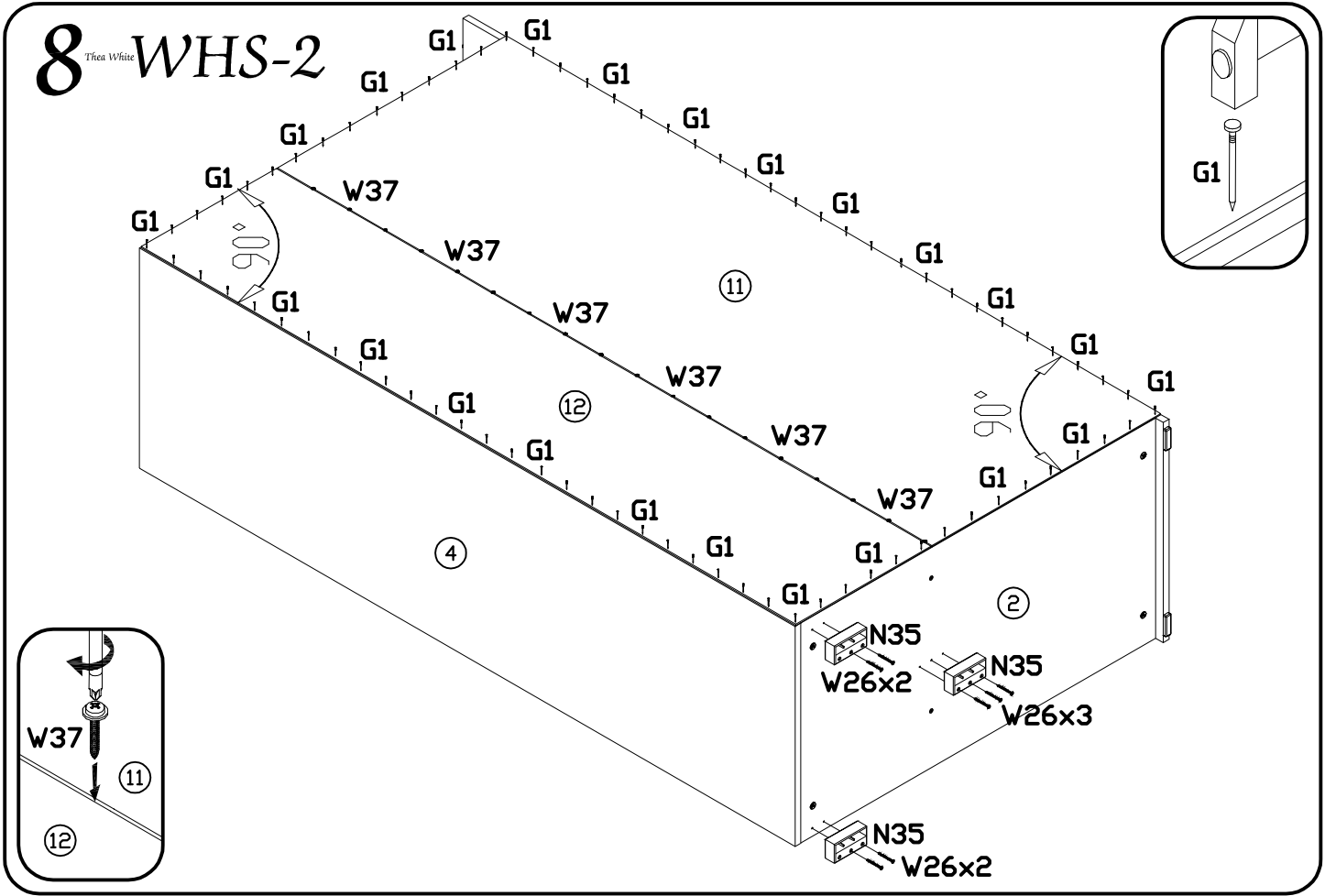

**PODCZAS MONTAŻU POSTĘPOWAĆ ZGODNIE Z INSTRUKCJĄ**

WHILE ASSEMBLING FOLLOW THE INSTRUCTION / MONTAGE LAUT DER AUFBAUANLEITUNG DURCHFÜHREN

PŘI MONTÁŽI POSTUPOVAT PODLE NÁVODU / PRI MONTÁŽI POSTUPOJTE PODĽA NÁVODU / SZERELÉSKOR UTASÍTÁS SZERINT ELJÁRNI

**9** Tea White **WHS-2**

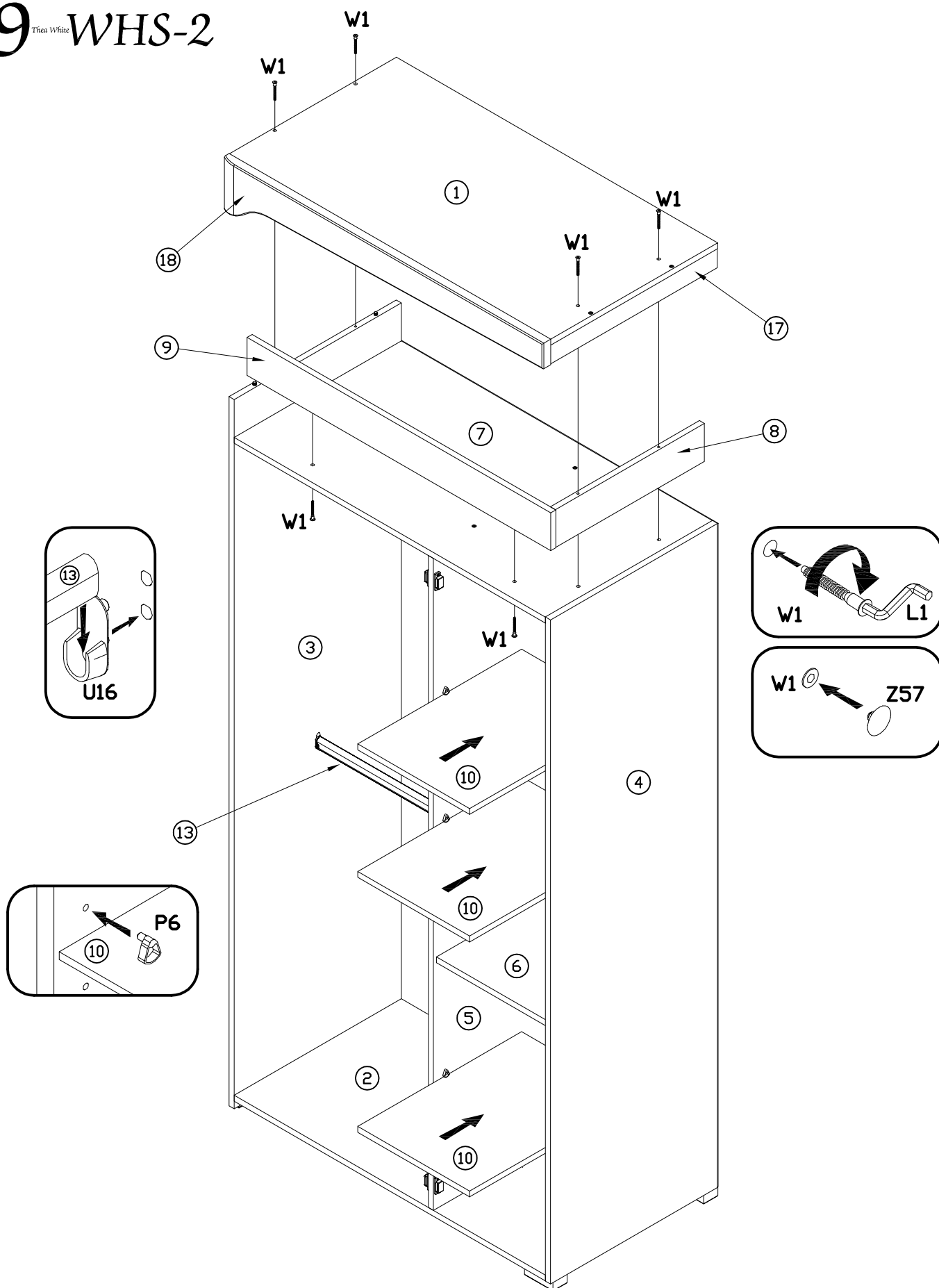

**PODCZAS MONTAŻU POSTĘPOWAĆ ZGODNIE Z INSTRUKCJĄ**

WHILE ASSEMBLING FOLLOW THE INSTRUCTION / MONTAGE LAUT DER AUFBAUANLEITUNG DURCHFÜHREN

PŘI MONTÁŽI POSTUPOVAT PODLE NÁVODU / PRI MONTÁŽI POSTUPOJTE PODĽA NÁVODU / SZERELÉSKOR UTASÍTÁS SZERINT ELJÁRNI

# 10 Třica White WHS-2

